

# **Shinebot W455**

Floor Washing Robot

## **User Guide**



English

Русский

For more details, please  
visit [www.iliferobot.com](http://www.iliferobot.com)

**ILIFE**



Thank you for choosing Shinebot W455 Floor Washing Robot!  
You've joined millions of people to get cleaning done robotically.

This user manual helps you to keep your robot performing at its best.  
Please take a few moments to read through it.

You may also connect with us on Facebook and Twitter to enjoy exclusive benefits:

- Get model-specific customer support, including Q&A, maintenance tips, demo videos, live chat and more;
- Get the most recent product updates including new product launches, exclusive discounts and special promotions.

You may find us on:

Facebook: [facebook.com/iliferobotics](https://facebook.com/iliferobotics)

Twitter: [twitter.com/ILIFEROBOTUS](https://twitter.com/ILIFEROBOTUS)

If you have any questions, please contact our customer service for assistance or visit [www.iliferobot.com](http://www.iliferobot.com) for more information.

Enjoy automated home cleaning performed by Shinebot W455.

ILIFE Innovation

## ILIFE Customer Service

### Russia



**89299401228** ( Mon-Fri: 9:00 - 18:00 )



[service\\_russia@iliferobot.com](mailto:service_russia@iliferobot.com)

### Other countries



[support@iliferobot.com](mailto:support@iliferobot.com)

# Contents

---

<b>1. Important Safety Instructions</b> .....	1
<b>2. Important Tips</b> .....	3
2.1 How to start .....	3
2.2 How to perform the best .....	3
<b>3. In the Box</b> .....	5
<b>4. Product Anatomy</b> .....	6
4.1 Main body .....	6
4.2 Display panel .....	6
4.3 Host machine .....	7
4.4 Remote control .....	9
4.5 Charging dock .....	9
4.6 Indicator .....	10
<b>5. Installation</b> .....	11
5.1 Install the charging dock .....	11
5.2 Install the main brush .....	12
5.3 Install the water tank .....	12
<b>6. Start Cleaning</b> .....	14
6.1 Select cleaning mode .....	14
6.2 Place the robot .....	16

# Contents

---

<b>7. APP Download</b> .....	17
<b>8. Maintenance</b> .....	18
8.1 Clean the dirty water tank .....	18
8.2 Clean the main brush and scraper .....	19
8.3 Clean the filter .....	20
8.4 Clean the water tank openings .....	20
8.5 Clean the metal pins on the dirty water tank /main body / charging dock .....	21
8.6 Clean the nose wheel .....	22
<b>9. Troubleshooting</b> .....	23
9.1 Voice alerts .....	23
9.2 Others .....	24
<b>10. Product specifications</b> .....	25

# Important Safety Instructions

---

- \* When using electrical appliance, basic precautions should always be followed, including the following:
- \* **Read all instructions before using this appliance.**



**WARNING** - To reduce the risk of fire, electric shock, or injury.

- Do not leave appliance when plugged in. Unplug from outlet when not in use and before servicing.
- Do not use outdoors.
- Do not allow device to be used as a toy. Close attention is necessary when used by or near children.
- Use only as described in this manual. Use only manufacturer's recommended attachments.
- Do not use with damaged power cord or plug. If appliance is not working as it should, or it has been dropped, damaged, left outdoors, or dropped into water, return it to a service center.
- Do not pull or carry by power cord, use power cord as a handle, close a door on power cord, or pull power cord around sharp edges or corners. Do not run appliance over power cord. Keep power cord away from heated surfaces.
- Do not unplug by pulling on power cord. To unplug, grasp the plug, not the power cord.
- Do not handle plug or appliance with wet hands.
- Do not put any objects into openings. Keep free of dust, lint, hair and anything that may reduce air flow.
- Keep hair, loose clothing, fingers, and all parts of body away from openings and moving parts.
- Turn off all controls before unplugging.
- Do not use the robot to wash flammable or combustible liquids, such as gasoline, or use in areas where they may be present.

# Important Safety Instructions

**!** CAUTION- To reduce the risk of injury from moving parts, unplug before servicing.

- Do not allow robot to clean anything that is burning or smoking, such as cigarettes, matches, or hot ashes.
- Do not use without water tank in place.
- Always insert batteries correctly with regard to polarity (+ and - ) marked on the battery and the product.
- Exhausted batteries should be immediately removed from product and properly disposed of.

## Intended use

- This product is intended for household use only. It is not intended for commercial use.
- This product is intended to work in environment between -10°C and 50°C.

## Tips and tricks

- Stop the appliance promptly if error occurs during cleaning. Before using the appliance, remove all power cords and small objects from on the floor.
- Roll up carpet tassels and make sure that curtains and tablecloths are not in contact with the floor.
- If there are any raised floors such as steps or stairs, test if the appliance can detect the height difference to prevent it from falling.
- Do not allow hair, clothes or fingers near openings or mechanical parts of the appliance.
- Do not put any objects in the roller brush holder. To ensure smooth rotation of the roller brush, remove dust, batting and any hair from around it.



# Important Tips



Shinebot W455 contains electronic parts. DO NOT immerse the robot's main body in water.

## How to start

- **Turn on/off**

To turn the robot on, press  for 0.5s. To turn it off, press  for 3s. Release the button after a sound alert.

- The robot will automatically enter sleep mode if no command is received within 20 minutes.

- **Pause/Resume**

To pause the robot, press  while it's cleaning. Press  again to resume the cleaning cycle.

- **Clean**

Install the main brush before use. Fill the clean water tank with clean water.

## How to perform the best

- Fill up the clean water tank before each use for better performance.
- Choose the Spot mode for areas with stubborn stains.
- Empty the dirty water tank after each use, and clean the water tank outlets and inlets regularly.
- Remove the main brush and rinse with water once a week.
- Clean both vents and remove the dust and debris regularly.
- The robot is skilled at cleaning up different types of stains, like milk, ketchup, coffee and footprints.





# Important Tips

• The robot works on a variety of hard floor surfaces, such as porcelain tiles, vinyl flooring, and laminated floors.

- The robot performs well on tile floor with small gaps.



- The robot does not work properly on tile floors with gaps wider than 10mm.

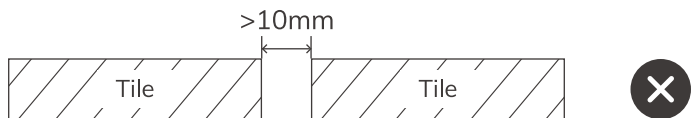

- The robot does not work properly on tile floors if the height difference between tiles is higher than 3mm.



- The robot does not work properly on uneven tile floors (more than 2mm in height).

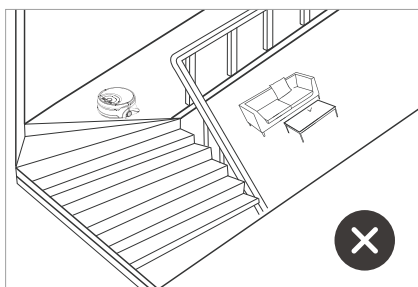

- Don't use the robot on the upper floor if there is a risk of it falling down.

- Don't use the robot on stairs to reduce the risk of it falling down.

# In the Box



Robot main body  
(include a main brush)



Charging dock



Adapter



Main brush

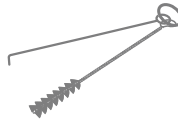

Cleaning tool



Remote control



User guide



AAA battery ( X2 )

## Main body

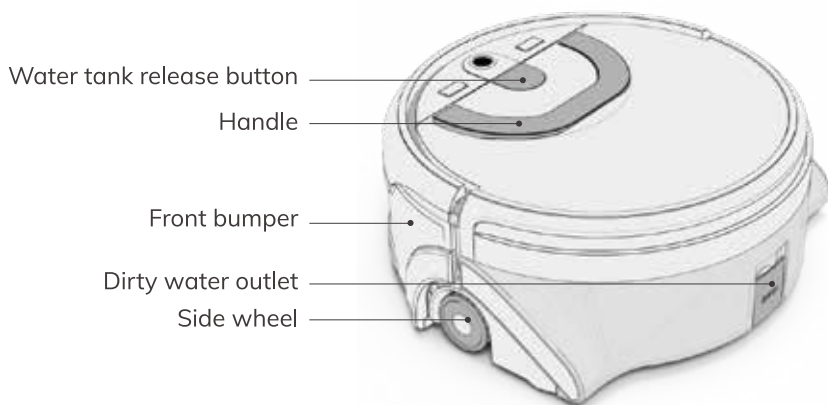

## Display panel

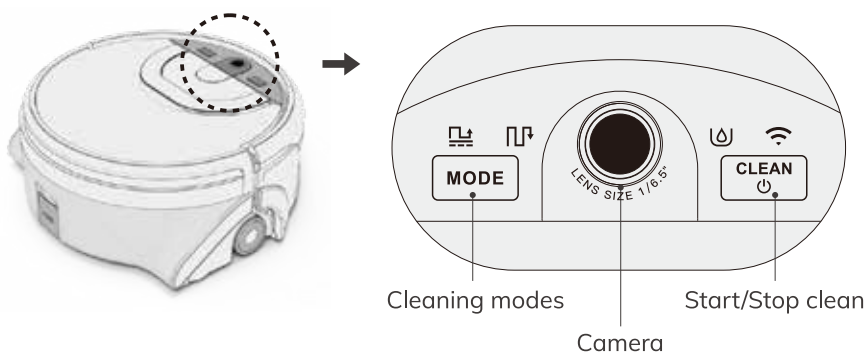

☐: Area mode

⚠: Water tank alert

⏸: Path mode

📶: WIFI indicator

# Product Anatomy

---

## Host machine

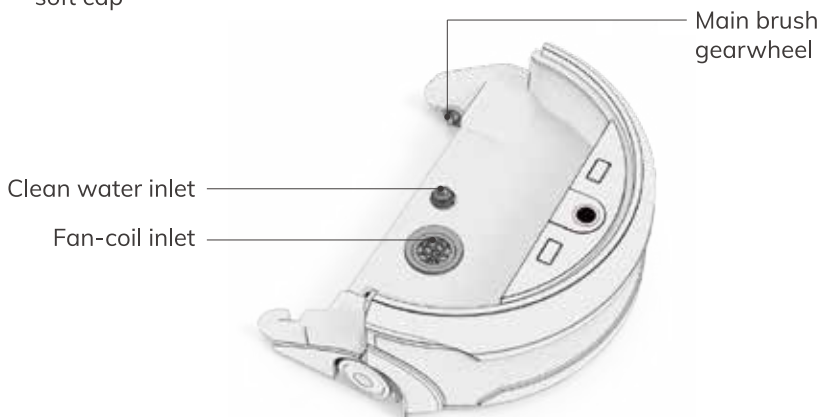
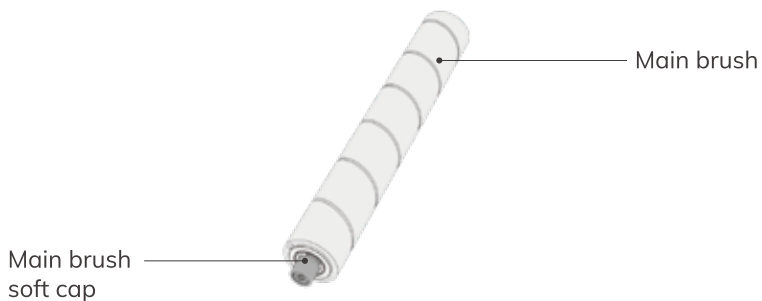
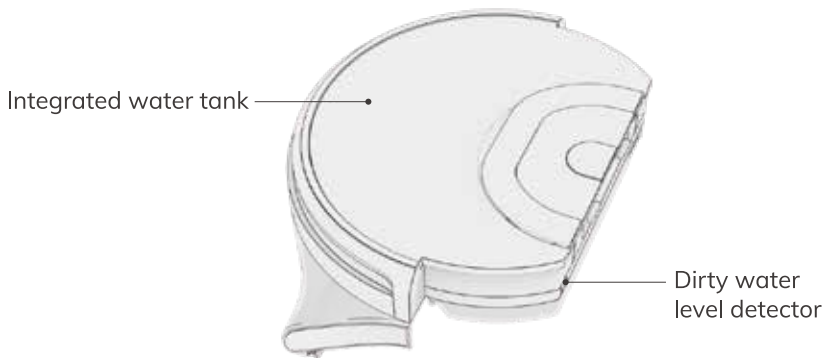

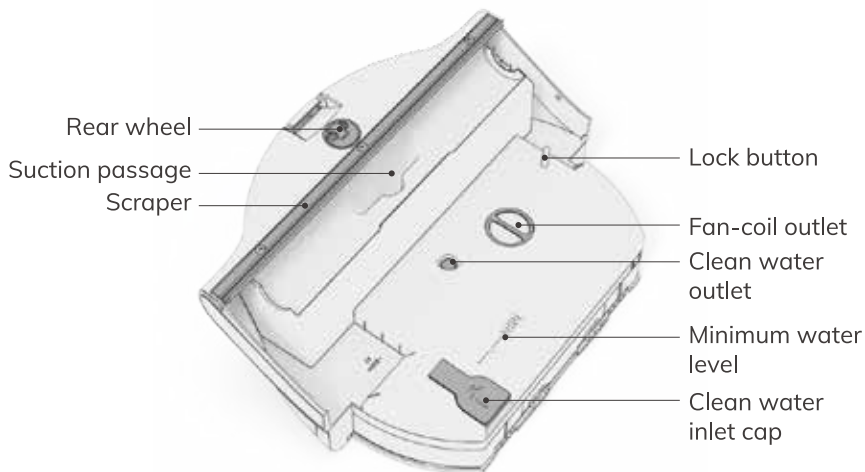
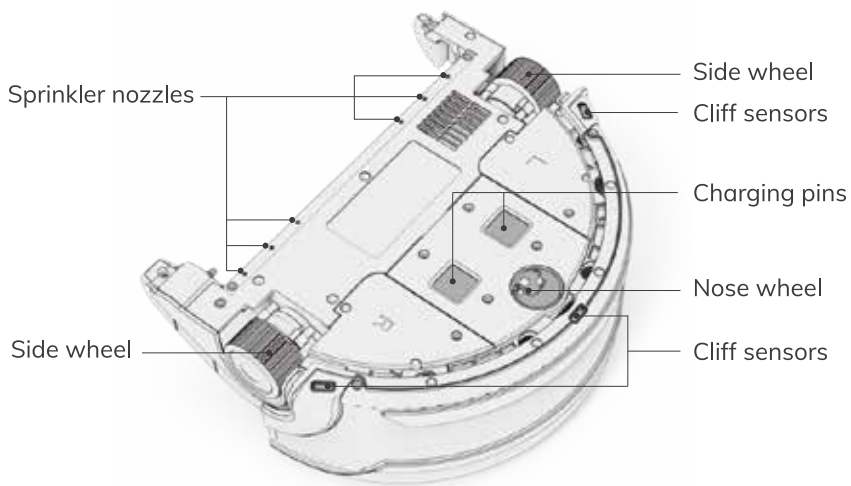

# Product Anatomy

## Remote control

- |  |             |
|--|-------------|
| ① Up   | ② Right     |
| ③ Left   | ④ Down      |
| ⑤ Path mode  | ⑥ Area mode |
| ⑦ Spot mode  |             |
| ⑧ Voice<br>(Turn on/off the voice alert)               |             |
| ⑨ Water flow<br>(Adjust water flow from 1st-3rd level) |             |
| ⑩ Repeat<br>(Repeat cleaning 3 times at max)           |             |
| ⑪ Brush<br>(Adjust brush speed from low to high)       |             |

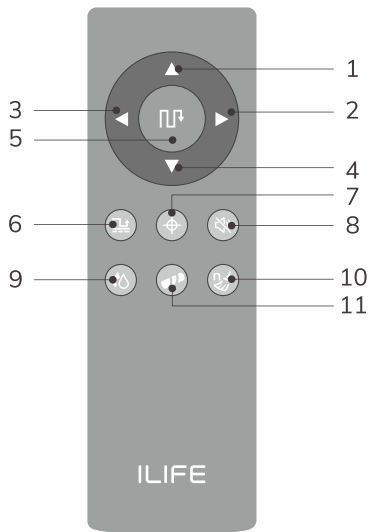





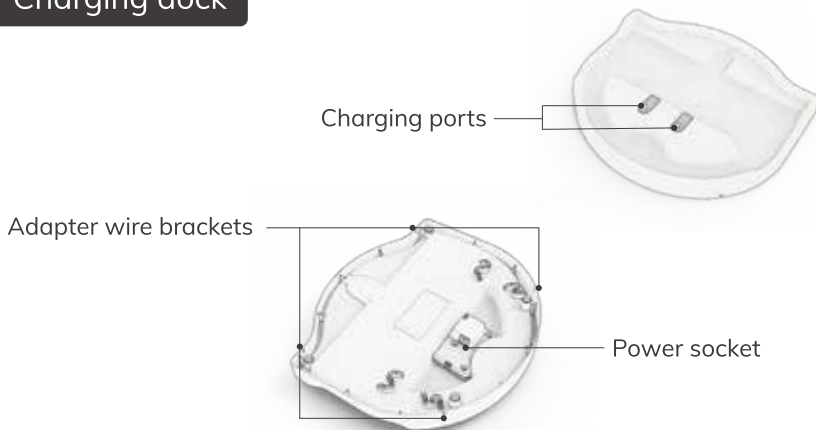





\* Up/Down/Left/Right Direction can only be changed when the robot is on standby.

## Charging dock



## Indicator

Lights	Status
 Orange light flashes	Charging
 Green Light goes out	Fully charged
 Green light flashes	Select modes
 Red light goes on	Machine fault
 Orange light flashes	Low battery
 Green light goes on	Auto Mode
 Green light goes on	Area Mode
 Green light goes on	Spot Mode
 <p>Green light goes on. Please refill the clean water according to voice alert. Green light goes on. Please empty the dirty water tank according to voice alert.</p>	Water
 <p>Green light flashing means it's connecting to the server. Green light going on means it's connected.</p>	Wi-Fi

# Installation

## Install the charging dock

Shinebot W455 is not a self-charging robot. Please take it to the dock manually for recharging after each use.

### Step 1



1 Turn the charging dock upside down.

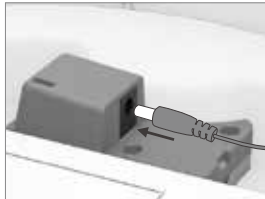

2 Plug in the power cord.



3 Secure wires around the cable channel.

### • Step 2

Put the charging dock somewhere level, dry and safe, and manually take the robot back to the charging dock to recharge.

### Voice alert: Start Charging



1 Put charging dock and the robot in right direction.



2 Take the robot back to charging dock.



Note: Do not put the main brush on the metal chips of the charging dock. The brushes may have residual moisture and cause damage.

## Battery condition

- If the light on  is orange, it means the battery is low. Please charge it immediately.

Working time	Green light	Orange light	Orange light flashes
	>30 mins	<30 mins	Recharge immediately



## Install the main brush

- It's recommended to properly dampen the main brush before installation for better cleaning performance.



- 1 Insert the recessed end of the main brush into the gearwheel.
- 2 Press down on the capped end into the other end of the main body.

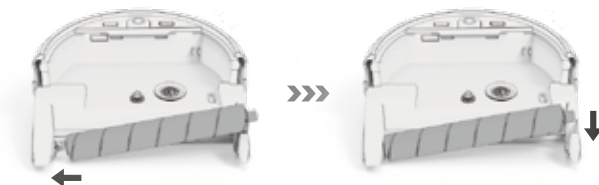

## Install the water tank

### Step1. Fill the water tank

- 1 Press down on the water tank release button, pull the handle up to detach the tank.
- 2 Turn the integrated water tank upside down.
- 3 Open the clean water tank cap and fill up the tank with clean water.
- 4 After filling up the water, erect the water tank to ensure that the water volume exceeds the minimum water level.



Note: 1. Do not use distilled or purified water.  
2. Do not add any detergents.

# Installation

## Step2. Install the water tank

- 1 Align the bottom of the integrated water tank with the main body and push forward.

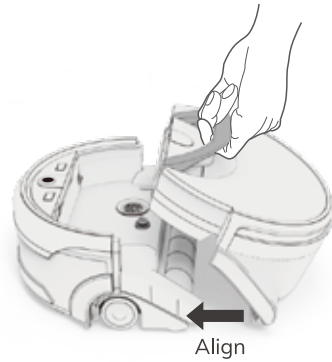

- 2 Align the ends and move the water tank to insert it into the main body.

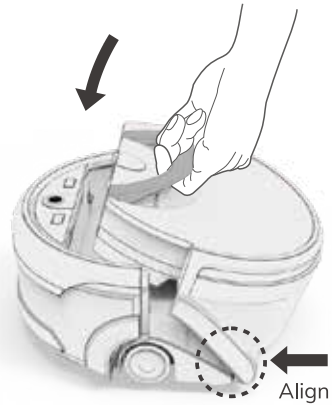

- 3 Press down, and a "click" will be heard if installed properly.



# Start Cleaning

## Select cleaning mode

Press **MODE** button or use the remote control/APP to change cleaning modes when the robot is in standby. Then press **CLEAN** button to start cleaning your home.

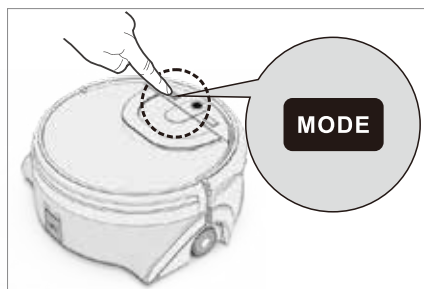

**A** Tap the **MODE** button to switch cleaning modes.

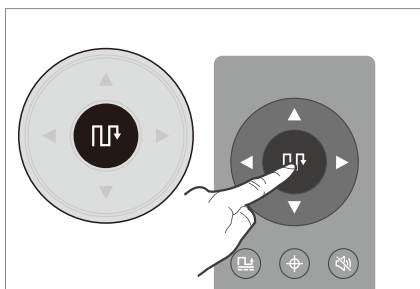

**B** Press **MODE** button on the remote control to switch modes directly.



**Note:**

The remote control can only be used when the robot is turned on.

## Standby mode

1. Press **MODE** button to choose cleaning mode. Press **MODE** button 3s to connect the robot to Wi-Fi.
2. Press **CLEAN** button to start cleaning, and press **CLEAN** button again for 3s to turn the robot off.
3. The robot will go to SLEEP mode if no command received in 20mins.



**Note:**

The above can only be operated in standby mode.

# Start Cleaning

## Area mode

- Recommended to clean a specific area. The robot will clean the area ahead of its starting point at zigzag path. It will return to the starting point when cleaning finished. Press  button to pause the robot. (The below right picture shows the cleaning path of area mode, subject to the actual situation. )

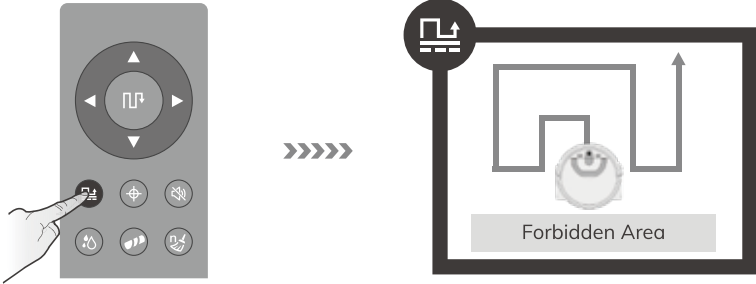

## Path mode

- Recommended to clean large area. The robot cleans in zigzag path and return to the starting point when cleaning finished automatically. Press  button to pause the robot. (The below right picture shows the cleaning path of path mode, subject to the actual situation. )

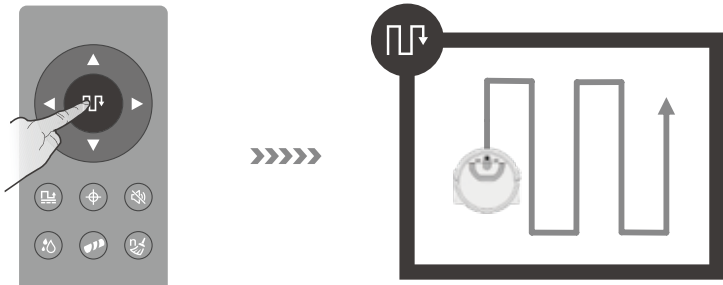

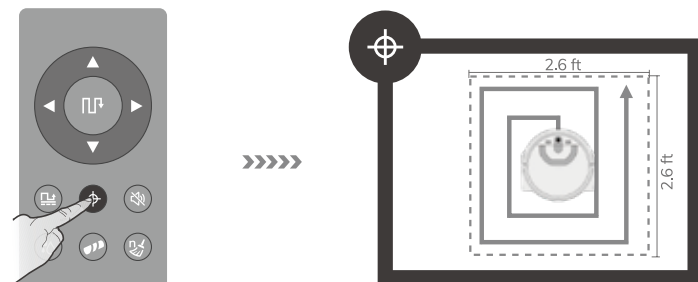

## Spot mode

- Recommended to clean a localized area with heavy stains. The robot cleans in “spiral” path and return to the starting point and goes into standby mode when cleaning finished automatically.  
(The below right picture shows the cleaning path of Spot mode, subject to the actual situation.)



## Place the robot

- Select cleaning mode and press  button start cleaning. For better cleaning efficiency, please place the robot stably against walls and keep 0.5m away from any obstacles.
- Press  button again to stop the robot from cleaning.
- The robot will work out the best cleaning path when running. If the robot is moved manually or by remote control, it gets disrupted and will work out a new cleaning path. In order to improve cleaning efficiency and reduce repeated cleaning, please do not move the robot when it's cleaning.

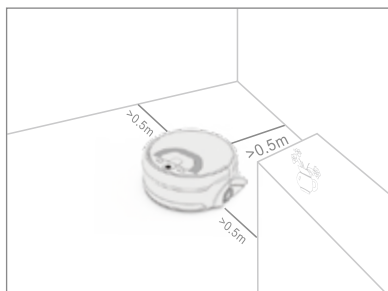

### Attention

1. The robot will return to the starting point when clean water runs out or the dirty water tank is full. Users should refill the clean water or empty the dirty water according to its voice prompts. Put the robot to the place where it stops cleaning and press the clean button to continue the work.
2. Please empty the dirty water tank after each cleaning, as well as cleaning up and maintaining the robot.

# APP Download

---

## Downloading the APP

The robot can be controlled by the “ILIFEHOME” app. Scan the QR code to install the app on your iOS or Android device.



- To keep the robot running at peak performance, you are advised to perform the following maintenance regularly:

Component	Maintain	Replace
Water tank	After each use	/
Main brush	Once per week	3-5 months
Suction passage	Once per week	/
Fan-coil outlet	Once per week	/
Nose wheel	Once per month	/

## Clean the dirty water tank

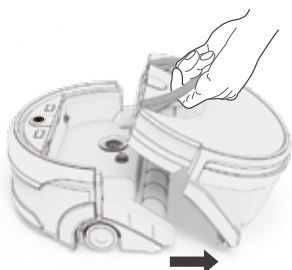

- 1 Detach the integrated water tank.



- 2 Open the cap and empty the waste.

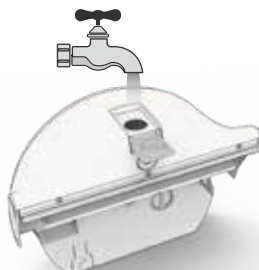

- 3 Fill the dirty water tank with clean water. Close the cap and shake.



- 4 Open the cap again and empty the tank.

# Maintenance

## Clean the main brush and scraper

- Remove the integrated water tank and take out the main brush, then rinse with clean water.



- 1 Detach the integrated water tank.

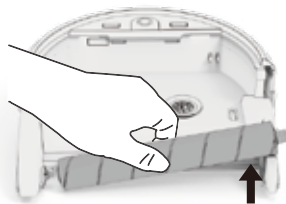

- 2 Remove the main brush from the robot body.



- 3 Remove all the debris on the main brush.



- 4 Rinse the main brush with clean water, and air dry it before reinstallation.



**Note:** The scraper is screwed to the robot. Please do not try to disassemble it and rinse it after each running.

- The scraper is fastened by the screws, which is not recommended to be detached. Please kindly rinse the scraper under the faucet.
- In order to keep the cleaning efficiency of the scraper, please place the robot correctly on the charging dock after cleaning or machine maintaining. Otherwise, the severe squeezing of the scraper will affect the cleaning efficiency (as shown in the figure below).

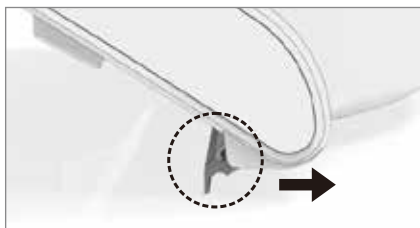



## Clean the filter

- Remove the filter from the water tank and rinse with water.



Remove the filter.

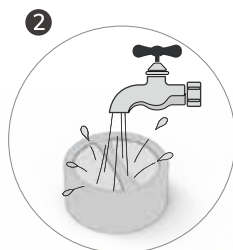

Rinse it with water.

## Clean the water tank openings

- After removing the filter, press the water tank lock button to open the fan-coil outlet. To maintain the water tank's proper functioning, clean both openings of the fan-coil outlet and remove dust and debris.

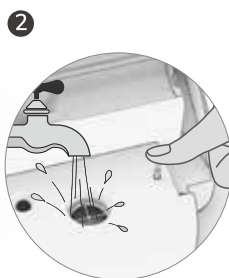
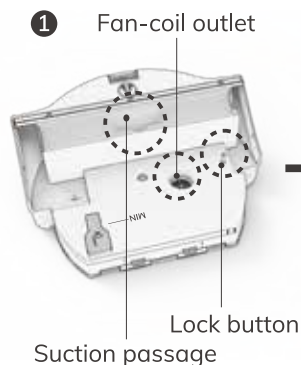

Press the lock button and clean the fan-coil outlet.



Clean the other suction passage.

# Maintenance

- To keep the tanks tightly sealed, clean the inlet and outlet, and the caps of both tanks regularly.

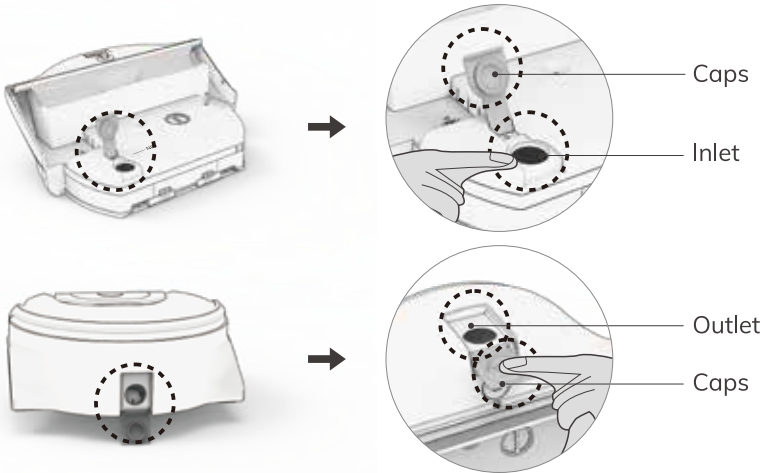

## Clean the metal pins on the dirty water tank / main body / charging dock

- Wipe the the metal pins on the dirty water tank /main body / charging dock regularly with dry clean cloth.

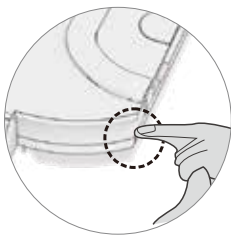

Metal pins on the dirty water tank



Metal pins on the main body

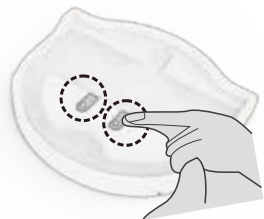

Metal pins on the charging dock

## Clean the nose wheel

- Turn the robot upside down and check if the nose wheel can rotate smoothly. Remove the nose wheel by pulling it out vertically. Check if there is any hair or debris stuck on it.

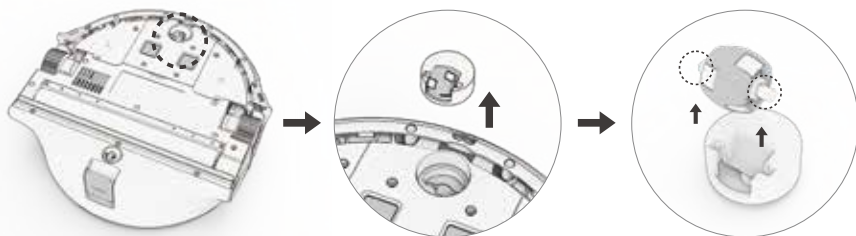





- 1 Turn the robot upside down.
- 2 Pull the nose wheel out vertically.
- 3 Check if there is any hair or debris stuck on it.



Note: After maintenance, reinstall all components and place the robot on the charging dock. Always store the robot in a safe environment.

# Troubleshooting

## • Voice Alerts

Alert	Light signal	Possible cause	Solution
Please install the water tank correctly	 The green light goes on	Water tank isn't installed or properly installed.	Ensure the water tank is installed properly.
Please fill the clean water tank	 The red light goes on	Clean water tank is empty or clogged.	<ul style="list-style-type: none"> <li>• Fill with clean water</li> <li>• Check the clean water outlet.</li> </ul>
Please empty the dirty water tank		Dirty water tank is full.	Empty the dirty water tank.
Please place the robot in an open area		Robot is stuck in a narrow space.	Put the robot in an open area and start cleaning again.
Please check the main brush		Main brush is jammed.	<ul style="list-style-type: none"> <li>• Check if the main brush is jammed because of an object.</li> <li>• Clean both ends of the main brush.</li> </ul>
Please check and clean the nose wheel	 The red light goes on	Nose wheel is stuck.	Check if the wheel is jammed by debris or hair. Remove the wheel and clean it.
Please check and clean the cliff sensor		Cliff sensors are contaminated.	Check and clean the cliff sensors.
Please put the robot back on the ground		Robot isn't on a flat surface.	Put the robot on a flat floor.
Please check the front bumper		Front bumper is stuck.	Press front bumper several times to see if the bumper works properly.
Low battery, please charge	 The orange light flashes	Battery is low.	Recharge the robot.

## Others

Malfunctions	Solutions
Dirty water leak	Check the air inlet and outlet. Clean up the sealing rings.
Do not suction	Check if the roller brush is installed. (Refer to page 12 as how to install) Check if the filter is blocked. (Refer to page 19 as how to clean filter)
Cannot charge	Check if the metal pins of both charging dock and the robot. Clean up if they are covered by dust.

# Product Specifications

---

Description	Specification
Battery	Li-ion
Adaptor	Input: AC 100-240V~50/60HZ
	Output: DC 19V 0.6A
Clean water tank capacity	0.85L
Dirty water tank capacity	0.9L
Charging time	<380mins
Working time	>80mins
Main body size	282 x 292 x 118mm
Charging dock size	289 x 315 x 49mm
Main body + Charging dock size	289 x 315 x 168mm



